

Mobile Examples

Ben Bederson
CMSC434 - Intro to HCI
Spring 2011

Slides (slightly) modified from Scott Klemmer





On a small screen, only content is retained. All navigational elements removed. Some tools are retained.

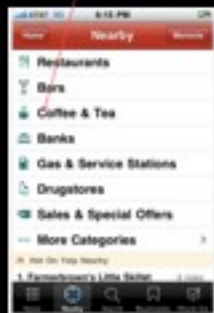

New

New



Overview and detail





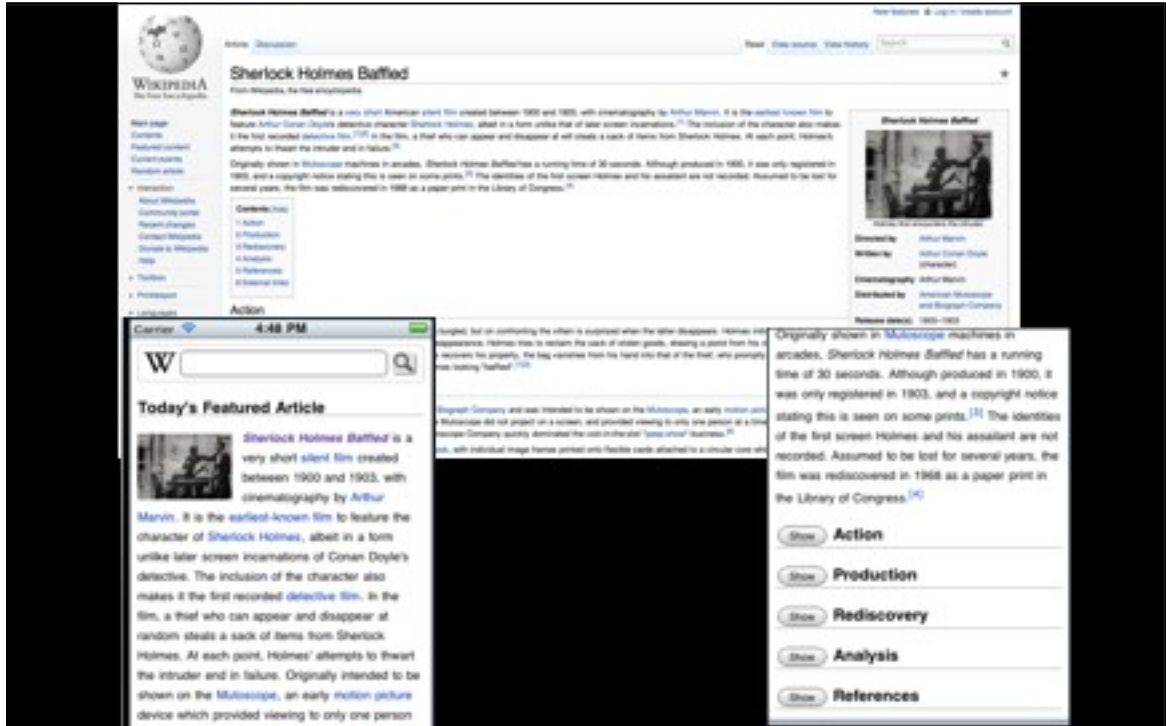

Site agnostic viewers

Specific to device rather than the website



Text

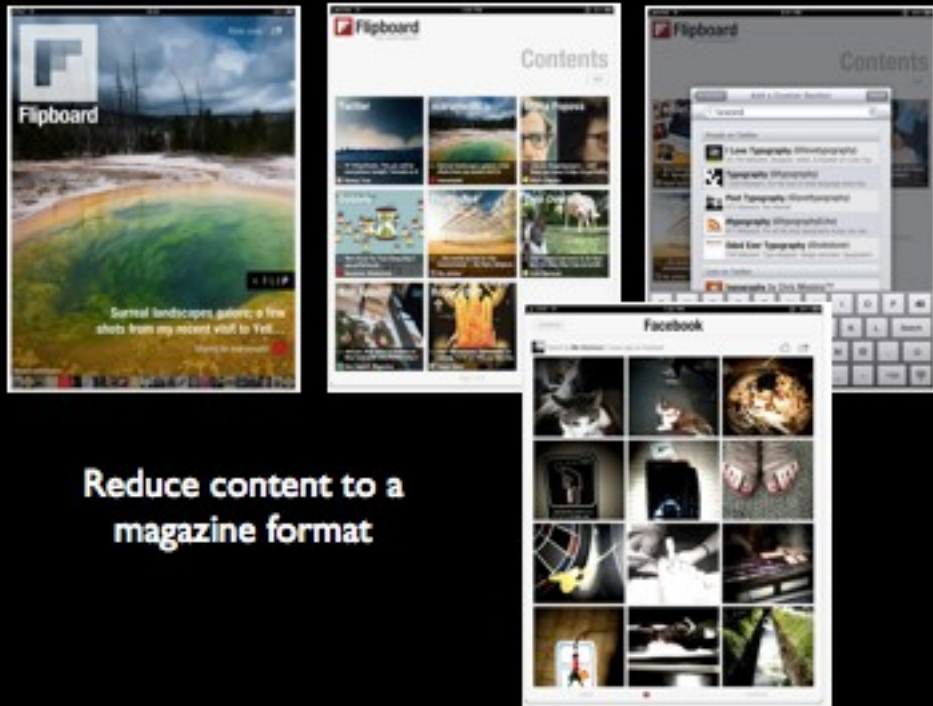

Reduce content to a magazine format



Mobile Screen Resolutions Are Improving

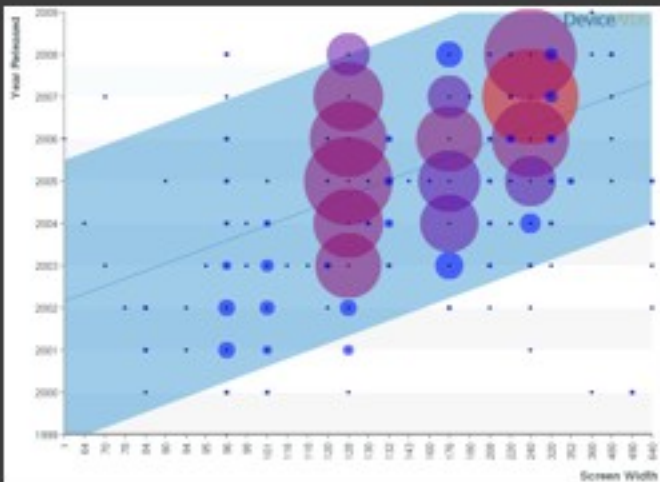

The Problem with Pixels

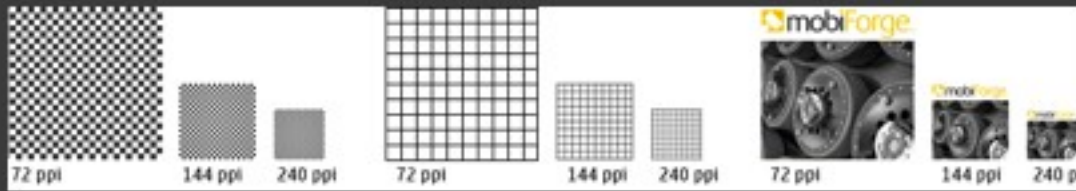

The value of designing with em's

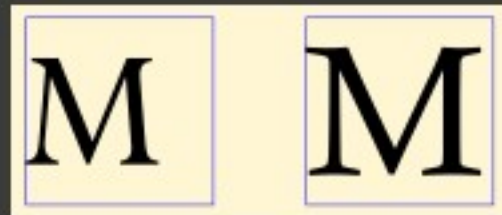
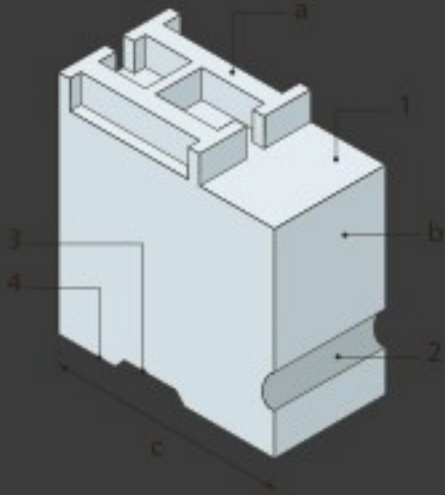

Create Flexible Assets



Create Fluid Layouts



Create a Reference Design



Putting it Together

